



2020 Annual Report

Message from PEIK

Dear PEIK members and supporters,

We invite you to read our annual report for 2020, a year which marked PEIK's 10th Anniversary. Due to pandemic conditions, we had to postpone large in-person celebrations and events, as we used to hold in recent years (see photo on the next page). In 2020, we were blessed with many group and individual awards and recognitions, as featured in the report. As we adapted to the unprecedented challenges, we also made good progress with the many activities and projects, including setting up new laboratories in the modernized Grehan Building. We look forward with optimism to returning to normal operations on campus and to in-person meetings. Please continue to follow our developments on the PEIK web page at <http://www.engr.uky.edu/power>, on [LinkedIn](#), and on [Twitter](#).

On behalf of PEIK faculty, staff, and students, and with many thanks for continued support,
Dan M. Ionel, Ph.D., FIEEE, PEIK Director and L. Staley Pigman Chair in Power

Our Team

UK Faculty and Staff with Primary Department Affiliations

Top Row (left to right): YT Cheng (CME), Don Colliver (BAE, KIAC Director), Aaron Cramer (ECE), Paul Dolloff (ECE, EKPC), Zongming Fei (CS)

Second Row: Jiangbiao He (ECE), Larry Holloway (ECE, UK Vice Provost), Dan M. Ionel (ECE, PEIK Director), Nicholas Jewell (ECE, LG&E-KU), Yuan Liao (ECE, Director of PEIK Graduate Certificate)

Third Row: Jeffrey Seay (CME, Paducah), Dusan Sekulic (ME), Simone Silvestri (CS), Vijay Singh (ECE), Joseph Sottile (MNG, ECE, Director of PEIK Undergraduate Certificate), Jason Souders (PEIK Coordinator).





PEIK and KIAC Receive Kentucky Energy and Environment Cabinet Award

The Power and Energy Institute of Kentucky (PEIK) and the Kentucky Industrial Assessment Center (KIAC) have received the 2020 Community Environmental Luminary Award from the Kentucky Energy and Environment Cabinet (EEC). The EEC's annual environmental awards of excellence were announced by Governor Andy Beshear and EEC Secretary Rebecca Goodman. The Community Environmental Luminary Award is given in recognition of outstanding achievements in education and outreach.

Housed within the University of Kentucky College of Engineering, PEIK was established in 2010 with multi-million-dollar support from the Department of Energy and continues its work with contributions and in collaboration with industry and utilities, community, and University. PEIK offers UK students the opportunity to earn undergraduate and graduate certificates in power and energy. The course offerings from several departments, which range from understanding global energy issues to alternative and renewable energy systems, provide technical knowledge and laboratory experience, as well as learning on the broader economic, environmental and social impacts of power. PEIK averages more than 1,000 enrollments in power and energy courses each year and has awarded a record number of certificates, more than 100 in the last two years alone, being one of the largest certificate programs within the UK College of Engineering.

KIAC, which is affiliated with PEIK, sends teams of faculty members and engineering students to conduct manufacturing plant energy assessments and make recommendations for potential savings opportunities. Through Department of Energy funding, the energy assessments are conducted entirely free of charge. KIAC has saved more than 95 businesses almost \$20 million, while providing significant reductions in energy use and contributing to environmental improvements and conservation. KIAC received the "National IAC of the Year" award in 2016. Mr. Jason Souders is the Program Coordinator for both PEIK and KIAC and Dr. Don Colliver, Professor in the UK Department of Biosystems and Agricultural Engineering, serves as KIAC Director. Photo taken prior to the pandemic.

PEIK Supporters

PEIK gratefully recognizes the support of the supporters



PPL companies



L. Stanley Pigman



PEIK also gratefully recognizes the support of: EKPC, Etap, GE, CMTA, Kentucky Power(AEP), Kentucky Energy and Environment Cabinet, Honda of America, Toyota, IEEE Power and Energy Society Lexington Chapter, Kentucky Association of Electric Co-ops(KAEC), ABB, Black and Veatch, Electric Power Research Institute(EPRI), S&C Electric, Schweitzer Engineering Labs and Texas Instruments.

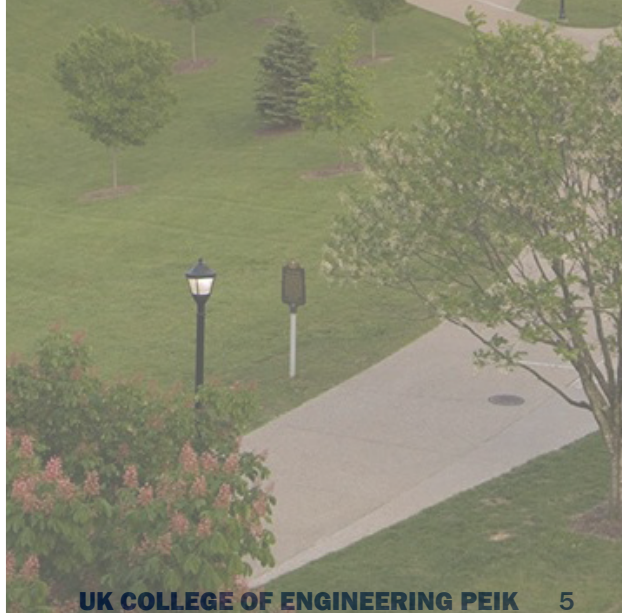

Contents

Awards & Recognitions

- 3 PEIK and KIAC Received Kentucky Energy and Environment Cabinet Award
- 8 Simone Silvestri, Computer Science and PEIK Faculty, Received Prestigious NSF CAREER Award
- 9 Dan M. Ionel, PEIK Director and L. Stanley Pigman Chair in Power, Received the Veinott Award from the IEEE Power and Energy Society
- 10 IEEE PES National Scholarships Awarded to Electrical Engineering and PEIK Students
- 11 Awards and Recognitions for UK Engineering Students on Topics of Power and Energy
- 12 Awards for PEIK and CS Research Students in Computer Science on Energy Topics
- 13 Electrical Engineering and PEIK Undergraduate Researcher, Rosemary Alden, Received Best Poster Award at 2020 IEEE PES GM
- 13 Computer Science and PEIK Undergraduate Researcher, Eura Shin, Received National Science Foundation Graduate Research Fellowship
- 14 PEIK and LG&E and KU Collaborative Research on Utility-Scale Batteries Received IEEE Paper Award

Teaching

- 16 PEIK Celebrates 10 years of Education, Research, and Outreach
- 17 PEIK Reports Success with Many Certificates Issued and Scholarships Awarded
- 17 PEIK Reports Annual Record for Graduate Certificates Issued
- 18 Online Certificate in Power Systems Offered at UK Since 2019

Contents

Research

- 19 Electrical Engineering and PEIK Faculty Dr. Aaron Cramer Received Grant from U.S. Navy Office of Naval Research
- 20 PEIK Faculty, Dr. Joseph Sottile, and Mining Engineering Colleagues Received Contract from NIOSH
- 21 SPARK and PEIK Collaborated with EPRI on the ENGAGE Distributed Energy Resources Project Funded by DOE
- 22 PEIK Researchers Participated in the Online IEEE ECCE 2020 Congress and Report on Government and Industry Sponsored Research
- 22 NSF Sponsored PEIK Project on Smart Buildings and Grid Expands with REU Supplement
- 23 PEIK and LG&E and KU Expand Research Collaboration on Renewable Energy and the Smart Grid
- 24 Materials Engineering Professor and PEIK Faculty, Dr. Yang-Tse Cheng, Initiated New Projects with General Motors and Pacific Industrial Development Corporation
- 25 Electrical Engineering and PEIK Faculty, Dr. JiangBiao He, Received Grant from U.S. DOE APRA-E
- 26 PEIK Researchers Participated in the Online IEEE ICRERA 2020 Conference and Present on Progress with NSF, NASA, and Power Utility Sponsored Research
- 26 PEIK Researchers Reported on DOE and NASA Sponsored Projects at the IEEE ITEC 2020 Conference
- 27 SPARK Lab Expanded Research on Electric Machines and Drives with QM Power Company
- 28 IEEE Power and Energy Society 2020 General Meeting - SPARK and PEIK Student Presentations and Best Poster Award

Outreach & Service

- 29 PEIK Online Seminar on Energy Storage Systems Presented by Schneider Electric's Keith Waters
- 29 Rodger Reiswig of Johnson Controls Delivered PEIK Online Seminar - Power Over Ethernet
- 30 Schneider Electric's Remi Bolduc Delivered PEIK Online Seminar - Harmonics Mitigation
- 30 Akeyo Oluwaseun of Sargent & Lundy and Recent UK PhD and PEIK Graduate Delivered IEEE Online Seminar on the Integration of Large PV Power Plants and Batteries
- 31 PEIK and ECE Students Established New IEEE PES and IAS Joint Chapter at UK
- 32 PEIK and LG&E-KU Expanded Displays and New Demonstrations at UK's E-Day 2020
- 33 Kentucky Industrial Assessment Center 2020 Progress Update

Simone Silvestri, Computer Science and PEIK Faculty, Received Prestigious NSF CAREER Award



Dr. Simone Silvestri joined the Computer Science Department within the College of Engineering at University of Kentucky as an Assistant Professor in 2017 and shortly afterwards he also became a PEIK faculty member. Dr. Silvestri recently received the prestigious National Science Foundation Faculty Early Career Development (CAREER) Award. The award recognizes and supports early-career faculty who have the potential to serve as role models in research and education and to lead advances in the mission of their academic organizations.

The project for this NSF CAREER award is titled “Energy Management for Smart Residential Environments through Human-in-the-loop Algorithm Design”. The residential sector is responsible for more than 20% of the total energy consumption of the United States, and this amount has been constantly increasing for several decades. Smart residential environments (SREs) are a new paradigm that envisions homes equipped with smart appliances based on the paradigm of

the Internet of Things. SREs offer tremendous potential to reduce the energy consumption of the residential sector; however, previous work in this context has largely overlooked the complexity of human behaviors and perceptions when interacting with such systems.

“The proposed research has the potential to transform the way in which energy management systems for Smart Residential Environments are designed, implemented, and used by people.”

The award will support Dr. Silvestri’s long term research goal of laying the foundations for a new field of study at the intersection of computer science and social sciences, where social-behavioral theories and models are integrated into new algorithmic, machine learning and optimization solutions for cyber-physical systems to specifically consider user behaviors, perceptions, and psychological processes in the design and operation of these systems. The research will enable further development of collaboration with faculty from different academic organizations and with PEIK’s industrial and utility partners. The NSF CAREER award, issued in March 2020, will last for five years.

Dan M. Ionel, PEIK Director and L. Stanley Pigman Chair in Power, Received the Veinott Award from the IEEE Power and Energy Society



Dan M. Ionel, Ph.D., IEEE Fellow, Professor of Electrical Engineering and L. Stanley Pigman Chair in Power, has received the prestigious Cyril G. Veinott Award. This is the highest distinction for electromechanical energy conversion, conferred to only one individual each year, by the IEEE Power and Energy Society (PES), which has approximately 40,000 members and is one of the largest societies within the IEEE, the world's largest technical professional organization dedicated to advancing technology. The Veinott Award is normally presented at the annual IEEE PES General Meeting, which this year was scheduled in Montreal, Canada, but due to current pandemic conditions was held online.

Dr. Ionel, who joined UK in 2015, currently teaches EGR 240 - Global Energy Issues, a core requirement for the Power and Energy Undergraduate Certificate, and a very popular class with almost 200 student enrollments each year. He also teaches advanced undergraduate and graduate EE elective courses at the 500 and 600 level on topics of renewable energy, electric power systems, electric and hybrid vehicles and aircrafts.

“I am honored to receive the PES Veinott Award and I am thankful to my professors, mentors, colleagues, and students for all their teachings and collaborative support over the years. I am working with the PEIK group to continue at University of Kentucky, the long-standing, more than half a century old, tradition of research in electric machines and drives.”

His immediate research group, the SPARK Laboratory, is working on projects with a total multi-million dollar budget sponsored by NSF, DOE, NASA, and directly by industry and power utilities, and includes more than 10 researchers, most of whom are PhD students. Dr. Ionel is currently developing the new SPARKS Laboratories, which are located in the recently modernized Grehan Hall, and benefit of large support from the university, industry, utilities, and private donors.

Since 2015, together with his research students and collaborators, Dr. Ionel co-authored more than 100 journal and conference papers, on topics of alternative and renewable energy technologies, battery energy storage, electric machines and power electronic drives, electric power systems, smart grids and buildings, and 3 books, including “Renewable Energy Devices and Systems – Simulations with MATLAB and ANSYS” published by CRC Press.

More information and Dr. Ionel's acceptance speech for the Veinott Award are available on the SPARK website (<http://sparklab.engr.uky.edu/>). At UK, Dr. Ionel also serves as the Director of the Power and Energy Institute of Kentucky (PEIK) (<https://www.engr.uky.edu/power>), a multi-disciplinary organization with more than 15 affiliated faculty from different Departments of UK's College of Engineering.

Awards & Recognitions

IEEE PES National Scholarships Awarded to Electrical Engineering and PEIK Students



Three PEIK and EE undergraduate students, Rosemary Alden, Hope Anderson, and Donovan Lewis have been each competitively awarded a 2020/2021 national IEEE Power and Energy Society (PES) Plus Initiative Scholarship. Rosemary (on the right in the photo taken during a recent Zoom online meeting) and Donovan (left in the photo), also received this yearly scholarship in 2019/2020. The two of them are University Scholars Program (USP) students in their senior BS year and will be continuing for Ph.D. studies at University of Kentucky. Their research this year is supported through an NSF REU and a NASA REU, respectively. Hope is a sophomore BS student, one of the youngest IEEE PES awardees, and her research this year is supported by the L. Stanley Pigman endowment. Each IEEE PES Scholarship recipient receives \$2,000 and membership to IEEE PES.

These awards continue the success enjoyed in recent years by UK and PEIK students. Also included in the photo is Stewart Evan Jones, who received in 2017/2018 and 2018/2019 the IEEE PES national scholarship as an undergraduate USP student and is now a Ph.D. student and GAANN fellow at UK where he worked on research projects sponsored by large utilities TVA and LG&E-KU. All four students are part of the SPARK Lab affiliated with PEIK and are advised by Dr. Dan M. Ionel, IEEE Fellow, ECE Professor, L. Stanley Pigman in Power, SPARK and PEIK Director.

The Institute of Electrical and Electronic Engineers (IEEE) is headquartered in New York City and is the world's largest association of technical professionals with more than 400,000 members. The Power and Energy Society (PES) is the oldest and one of the largest societies within the IEEE with approximately 40,000 members. Earlier this year, the EE and PEIK students have established a new chapter of IEEE PES at UK.

Awards and Recognitions for UK Engineering Students on Topics of Power and Energy



The excellent progress of College of Engineering students and their achievements have been recently recognized at UK and nationally. The list of our new awardees includes:

- Rosemary Alden, H. Alex Romanowitz Memorial Award from the ECE Department and National Science Foundation REU Student
- Trevor Arvin, ECE Research Symposium Best BS Student Presentation
- Tyler Cultice, ECE Undergraduate Research Fellowship
- Damien Lawhorn, ECE Research Symposium Best PhD Student Presentation
- Donovan Lewis, ECE Undergraduate Research Fellowship
- Ben Lockett, Robert L. Cosgriff Award from the ECE Department
- Nelson Penn, National Science Foundation REU Student
- Eura Shin, National Science Foundation Graduate Fellowship.

The students have worked with their faculty advisors, Drs. Jiangbiao He, Dan M. Ionel, Simone Silvestri, and Himanshu Thapliyal on topics of power and energy. (The above photo of a group of students, which is included for illustration purposes, was taken during a field trip visit before the pandemic).

Dr. Joseph Sottile, PEIK Director of Undergraduate Studies, announced that more than thirty PEIK certificates will be issued this year. The E.On scholarships for PEIK will be awarded later this summer by UK College of Engineering.

Awards for PEIK and CS Research Students in Computer Science on Energy Topics



Two CS students working with PEIK Faculty Simone Silvestri on energy related projects have recently received awards and recognition for their research.

Eura has worked with Dr. Silvestri since 2017 on energy management systems based on machine learning and artificial intelligence. She has also published two papers, “Machine Learning in the Wild: The Case of User-Centered Learning in Cyber Physical Systems”, appearing in the proceedings of the IEEE International Conference on COMMunication Systems & NETWORKS (COMSNETS), 2020, and “A User-Centered Active Learning Approach for Appliance Recognition”, which appears in the proceedings of the IEEE International Conference on Smart Computing (SMARTCOMP), 2020. Thanks to this work, Eura won a prestigious Barry Goldwater Scholarship and received the Honorable Mention for the Computing Research Association’s (CRA) Outstanding Undergraduate Researcher Award for 2020. Eura plans to earn a Ph.D. in computer science and pursue a position as a professor of computer science.

Seun Adekunle, a high school student from the Paul Laurence Dunbar High School, has worked with Dr. Silvestri on a project to interface a smart outlet with a web server and a smart phone application. Seun won the second place for his poster at the KY State Science Fair, Energy: Physical category. (Photo taken prior to the pandemic.)

Electrical Engineering and PEIK Undergraduate Researcher, Rosemary Alden, Received Best Poster Award at 2020 IEEE PES GM



Rosemary E. Alden, a Senior Electrical Engineering (EE) Bachelor and Science (BS) and University Scholars Program (USP) student, was recently awarded the First Prize in the Undergraduate Student Poster Contest organized during the 2020 IEEE Power and Energy Society (PES) General Meeting (GM). The conference, which is the flagship annual event of PES, one of the largest societies within IEEE, typically gathers more than 2,500 participants. This year's edition was originally scheduled for Montreal, Canada and was held online due to the pandemic conditions.

The award-winning poster, "Tradeoffs in Forecasting of Residential Electric Loads with Data from Smart Meters and Intelligent Circuit Breakers", covers Rosemary's most recent research on advanced topics of smart buildings and grids. Last year, her earlier work on smart plugs for electric power monitoring was published in an IEEE conference proceedings paper at ICRERA 2019 and also received at UK an Honorable Mention in the Oswald Undergraduate Research Competition. Rosemary is a national IEEE PES Plus Initiative Scholar and currently serves as the Chair for the new IEEE PES Student Chapter at UK.

As an USP student, Rosemary is integrating her BS and PhD studies, and is also pursuing the PEIK certificate. Her research in the current academic year will be supported by an NSF REU supplement to the collaborative project "Crosslayer Optimization of Energy and Cost through Unified Modeling of User Behavior and Storage in Multiple Buildings", which is led at UK by Drs. Simone Silvestri and Dan M. Ionel and at Marquette University by Dr. Cris Ababei. Rosemary started her research at UK in the fall of 2018 in the SPARK Laboratory and is advised by Dr. Dan M. Ionel, FIEEE, ECE Professor, L. Stanley Pigman Chair in Power, and PEIK Director.

Computer Science and PEIK Undergraduate Researcher, Eura Shin, Received National Science Foundation Graduate Research Fellowship

Eura Shin, a recent computer science BS graduate, has received a National Science Foundation (NSF) Graduate Research Fellowship. NSF Fellows receive a three-year annual stipend of \$34,000 along with a \$12,000 cost of education allowance for tuition and fees for a research-based master's or doctoral degree in a STEM field. Annually, the NSF awards approximately 1,500 fellowships from an applicant pool of over 12,000.

Shin, a Lewis Honors College member from Morehead, Kentucky, will pursue a PhD in computer science at Harvard University. Since the spring 2017 semester, Eura worked with computer science assistant professor and PEIK faculty, Simone Silvestri, on research projects related to machine learning and artificial intelligence (AI) for energy in smart homes and grids.



PEIK and LG&E and KU Collaborative Research on Utility-Scale Batteries Received IEEE Paper Award



Researchers from the SPARK group within the Power and Energy Institute of Kentucky (PEIK) and from Louisville Gas and Electric Company and Kentucky Utilities Company (LG&E and KU) have recently received from the IEEE Industry Applications Society (IAS), Renewable Energy Systems Committee, a Transactions Paper Award - Third Prize for the manuscript entitled “Incorporating Battery Energy Storage Systems into Multi-MW Grid Connected PV Systems”, which was published in the flagship peer-reviewed journal IEEE Trans on IAS. Most recent research by the group has been just published in the widely circulated peer-reviewed IEEE Access journal in the paper “Parameter Identification for Cells, Modules, Racks, and Battery for Utility-Scale Energy Storage Systems”. The Institute of Electrical and Electronic Engineers (IEEE) is the world’s largest association of technical professionals with more than 400,000 members worldwide and the IAS is one of its large societies.

The publications are reflective of the strong collaboration between PEIK and LG&E and KU on timely topics of new technologies for renewable energy generation and storage in the electric power systems. Since 2018, the joint research group actively working on utility-scale large electric batteries and solar PV topics included at UK: Oluwaseun M. Akeyo, Ph.D. student, Vandana Rallabandi, Postdoctoral Researcher, and Dan M. Ionel, EE Professor and L. Stanley Pigman Chair in Power, SPARK Lab and PEIK Institute Director, and at LG&E and KU: Nicholas Jewell, Senior Engineer, and Aron Patrick, Manager Technology Research and Analysis. Authors’ versions of the technical papers are available from the [SPARK Lab website](#). Photo taken prior to the pandemic.

PEIK Success Metrics for the Last 3 Years

Undergrad power and energy
course enrollments at UK

4,000+

Undergrad PEIK certificate core
Global Energy Issues course enrollments

600+

Undergraduate PEIK certificates issued

130+

Graduate PEIK Certificates issued

10+

Continuing education training course,
seminar, and workshop events

40+

PDH (Professional Development Hours) credits
issued free of charge

450+

E.On endowment, on behalf of Kentucky Utilities, student
scholarships for PEIK awarded

75+

Ten Years of PEIK



PEIK promotes, coordinates, and supports power and energy courses and curriculum at UK, including graduate and undergraduate certificates in power and energy. PEIK, established in 2010 with a \$2.5M DOE grant for energy workforce development, builds upon UK's strengths across multiple engineering disciplines. The Institute has more than 12 affiliated faculty from diverse academic departments with extensive research, education, and industrial expertise. Dr. Dan M. lonel, Professor and L. Stanley Pigman Chair in Power, was appointed as Director of PEIK in July 2017. The founding Director of PEIK, Dr. Larry Holloway, TVA Professor, now serves as Vice Provost at UK. PEIK educates the next generation of power PEIK fosters partnerships with industry and utilities, and with other academic and research organizations.

2020 Undergraduate Certificates

In 2020, UK awarded 43 students with the Undergraduate Certificate in Power and Energy. This certificate program consists of a series of foundational courses supplemented by a broad array of elective courses related to power and energy developed to prepare the students for a successful career in industry and the electric utilities. The list of majors for the students who were issued the certificate this year includes Chemical and Materials Engineering, Electrical Engineering, Mechanical Engineering, and Mining Engineering. A total of 130 students have received the Undergraduate Certificate in Power and Energy over the last three years. Dr. Joseph Sottile is the Director of the Undergraduate Certificate in Power and Energy program. For more information on the Undergraduate Certificate visit the [PEIK Undergraduate Certificate Webpage](#).



2020 E. On Scholarships

The UK College of Engineering has awarded 16 E.ON Scholarships for PEIK to eligible students who demonstrated strong interest in power and energy studies. These annual scholarships that continue to be supported by the endowment established years ago at UK by E.ON, on behalf of Kentucky Utilities, provide recipients between \$2,000 and \$3,000 annually and may also grant an additional \$2,000 for use on a power and energy related study abroad trip during the school year or the following summer.

Louisville Gas and Electric and Kentucky Utilities (LG&E and KU) continue to be strong supporters of UK and PEIK teaching, research, and outreach programs. For more information about Power and Energy scholarships visit the [PEIK Scholarship Webpage](#).



2020 Graduate Certificates

Over the last academic year, 2019-2020, UK College of Engineering awarded seven students with the graduate certificate in Power and Energy and one graduate certificate in the newly established online Power Systems graduate certificate program. The graduate certificate in Power and Energy provides students with state of the art knowledge in power and energy areas and shows the graduates dedication to this area of study. Dr. Yuan Liao is the Director of the Graduate Certificate in Power and Energy program.

For more information about the graduate certificate visit the [PEIK Graduate Certificate webpage](#).



Online Certificate in Power Systems Offered at UK Since 2019



The University of Kentucky College of Engineering is now offering a graduate certificate in power systems that will be available entirely online and is designed to provide students with the core knowledge and latest advancements in analysis, modeling, operation, control, optimization and integration of renewable energies. In addition to being exposed to the various theories, students will master the tools and techniques for planning, problem solving and operating power systems. Dr. Yuan Liao, PEIK faculty and EE Professor, serves as the director for the program. Dr. Liao also serves at the director for the graduate certificate in power and energy.

For more information about the online Power Systems graduate certificate visit <https://www.engr.uky.edu/power/power-and-energy-institute-kentucky/education/power-systems-online-graduate-certificate>.

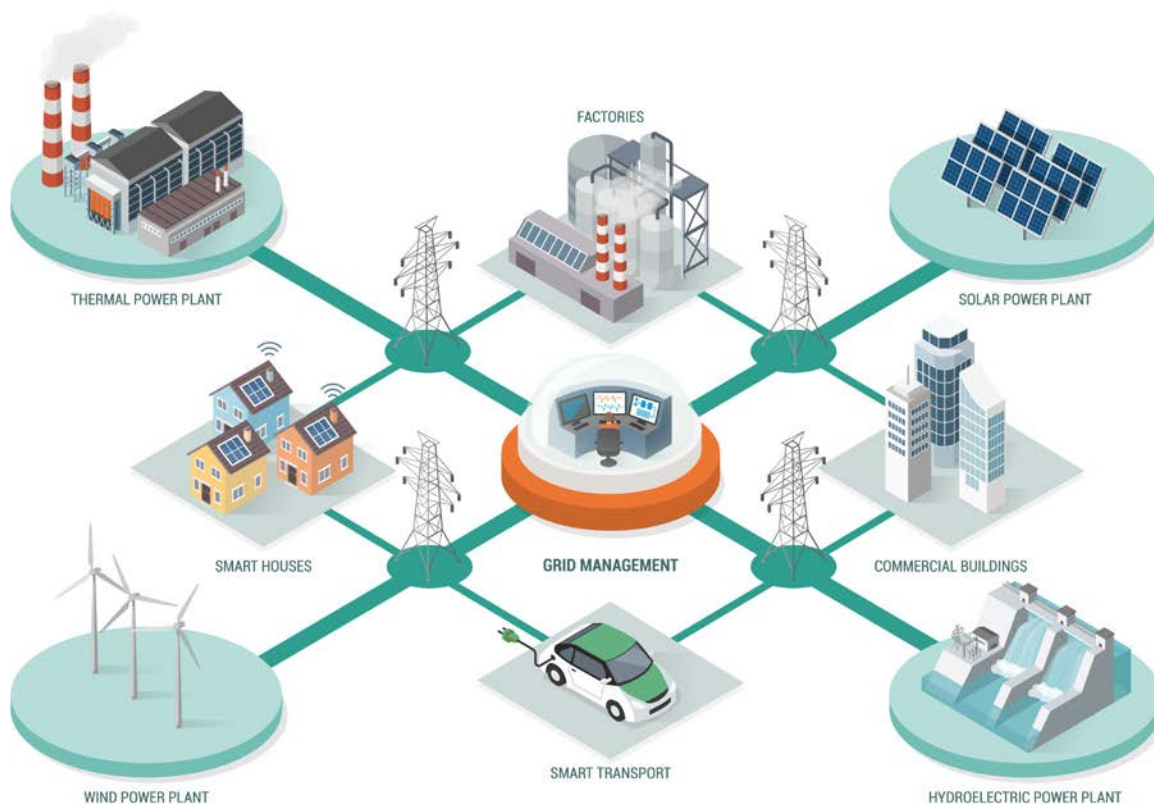

Electrical Engineering and PEIK Faculty Dr. Aaron Cramer Recieved Grant from U.S. Navy Office of Naval Research



Electrical Engineering and PEIK Faculty Dr. Aaron Cramer, has been awarded a grant from the U.S. Navy Office of Naval Research. The new project seeks to advance the metric-based evaluation of control system performance by evaluating optimal-control-based system techniques, integrating of control-based evaluation with other system metrics, and assessing control implementation opportunities. Contributions in these areas will immediately improve the capability of control system evaluation and will ultimately lead to new techniques for the development of control systems for complex, multi-mission systems. The project will be funded for approx. \$360,000 over three years.

Advances in shipboard power systems are creating new opportunities to apply energy to meet the mission needs of the warfighter, but the growing complexity of such systems is creating new challenges for the control systems that must govern them. Enhancements in analysis and design techniques will improve resource utilization, allowing the system to operate more efficiently and/or with greater performance.



PEIK Faculty, Dr. Joseph Sottile, and Mining Engineering Colleagues Received Contract from NIOSH

Dr. Joseph Sottile, Director of the Undergraduate Certificate in Power and Energy, Mining and Electrical Engineering Professor, together with Associate Professor Steven Schafrik and Mining Engineering Foundation Professor and Chair Zach Agioutantis, both in Mining Engineering, received a \$650,000 contract from the National Institute for Occupational Safety and Health (NIOSH). The project, which will advance underground mine equipment autonomous operation, will span two years.

The research will focus on shuttle car navigation at, or near, the continuous miner during cutting and loading operations, because this represents a particularly hazardous situation. The main objective is to develop autonomous navigation concepts for navigating a shuttle car from the continuous miner change point to the continuous miner coal-discharge conveyor under various situations representing realistic mining conditions. These developments will be demonstrated with a shuttle car and continuous miner in a realistic environment. The results of the project will enhance miner health and safety, and the concepts developed are expected to be applicable to other mining applications.

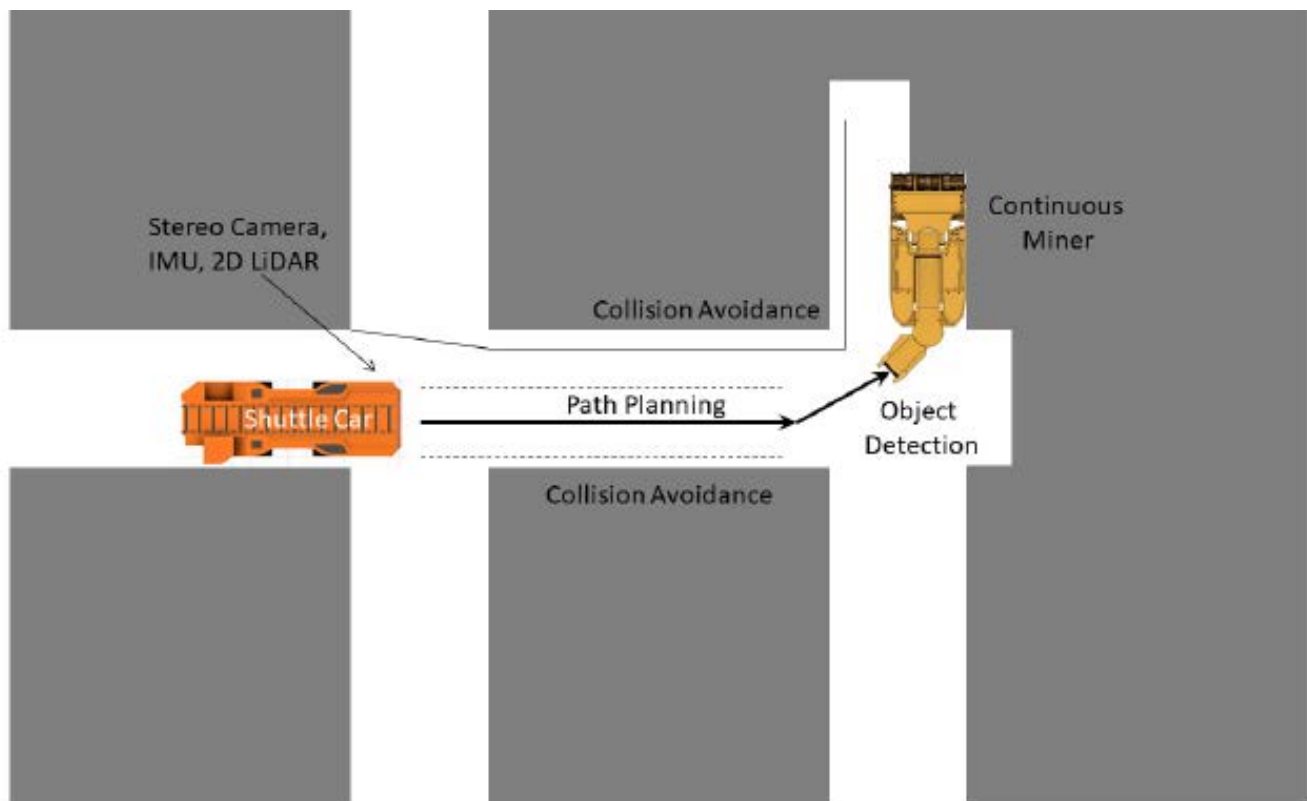
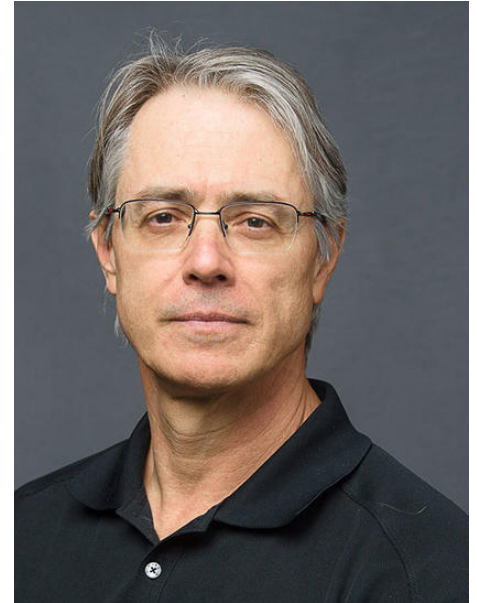

SPARK and PEIK Collaborate with EPRI on the ENGAGE Distributed Energy Resources Project Funded by DOE

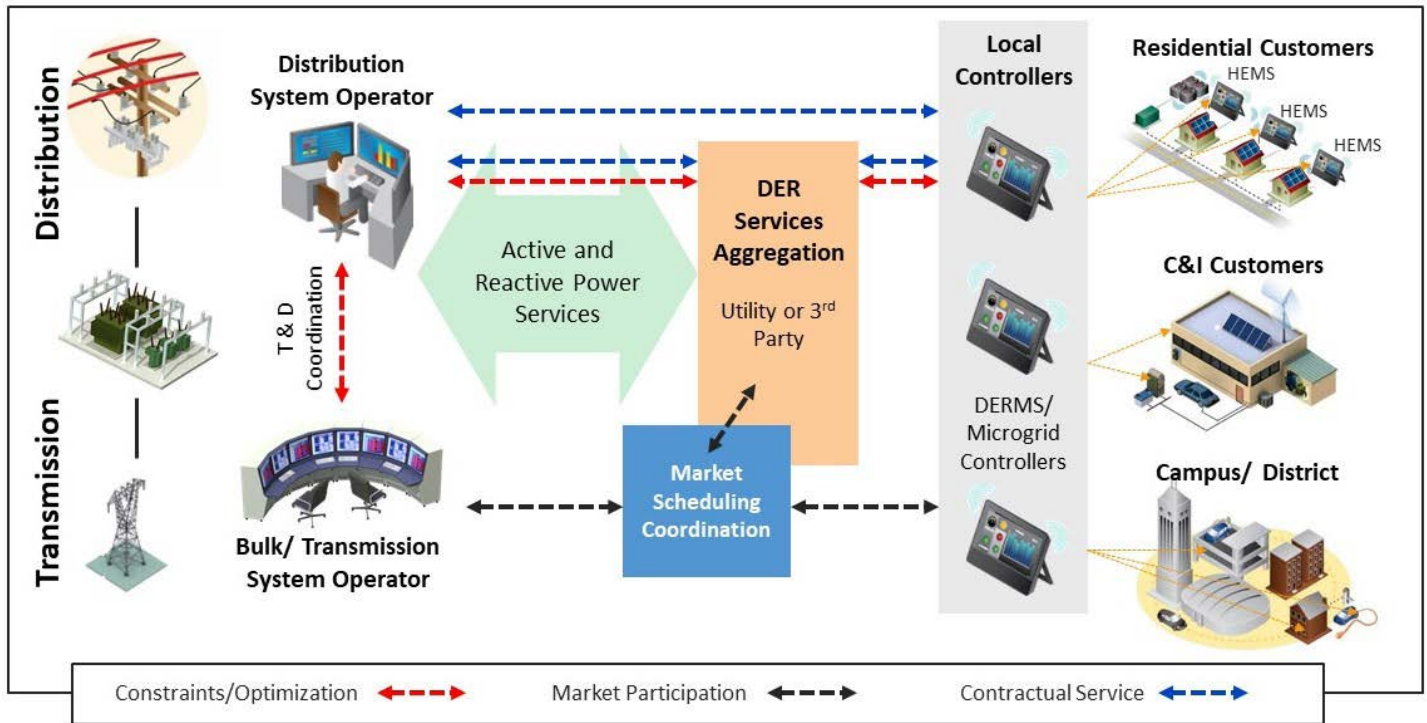

The SPARK research group affiliated with the Power and Energy Institute of Kentucky (PEIK) will participate in a newly awarded research project led by the Electric Power Research Institute (EPRI), in collaboration with utilities and industry, and funded by the U.S. Department of Energy (DOE). At EPRI, the large collaborative project is led by Dr. Aminul Huque, Principal Project Manager, and at UK, Dr. Dan M. Ionel, FIEEE, ECE Professor and L. Stanley Pigman Chair in Power, SPARK and PEIK Director, serves as PI.

The research will develop and test an end-to-end aggregation and control architecture for Distributed Energy Resources (DER). The architecture would be designed to enable behind-the-meter (BTM) solar photovoltaic (PV) systems to be co-located with other DER to provide both bulk power and distribution grid services. The multi-institutional team will conduct advanced transmission, distribution, and DER simulations to validate the merit and performance of DER-provided services, and better estimate the potential need for network upgrades. The multi-year project is entitled “Enable BTM DER-provided Grid Services that Maximize Customer and Grid Benefits (ENGAGE)”, received a DOE award of \$3 million and will additionally benefit of a \$1.1 million cost-share budget contribution.

The SPARK and PEIK research contributions to the project will build upon expertise in DER optimization and co-simulation of smart homes and grids with the EnergyPlus and OpenDSS open-source software, as illustrated in recently published papers. These are available, in authors’ manuscript versions, from the SPARK Lab website, and include contributions by PEIK faculty, Drs. Dan M. Ionel and Don Colliver, and SPARK Lab Ph.D. and research students: Huangjie Gong, Evan S. Jones, and Rosemary E. Alden.

PEIK Researchers Participated in the Online IEEE ECCE 2020 Congress and Report on Government and Industry Sponsored Research



Power and Energy Institute of Kentucky (PEIK) and University of Kentucky (UK) College of Engineering faculty, including: Don Colliver, Aaron Cramer, Jiangbiao He, Dan M. Ionel,

and Yuan Liao, and postdoctoral researcher Peng Han, together with research students, including: Oluwaseun Akeyo, Rosemary Alden, Huangjie Gong, Evan S. Jones, Murat Kesgin, Damien Lawhorn, Donovan Lewis, Pranoy Kumar Singha Roy, and Yibin Zhang contributed papers and presentations to the IEEE ECCE 2020 Congress and the IAS Annual Meeting. The papers cover topics of smart grids and homes, renewable energy devices and systems, energy storage, power electronics, electric machines, and recent research projects sponsored by the National Science Foundation (NSF), Department of Energy (DOE), and directly by industry and utilities, including: ANSYS, Inc., Regal Beloit Corp., Schneider Electric, and Tennessee Valley Authority (TVA).

The Energy Conversion Congress and Exhibition (ECCE) is the largest annual joint event of the IEEE Industry Applications and IEEE Power Electronics Societies, which typically attracts approximately 2,000 attendees. The Industry Applications Society (IAS) Annual Meeting was co-located with ECCE and the two events, which were originally scheduled for Detroit, MI, have been organized on-line due to pandemic conditions.

NSF Sponsored PEIK Project on Smart Buildings and Grid Expanded with REU Supplement



**Research Experiences
for Undergraduates
National Science Foundation**

The National Science Foundation (NSF) project: “Crosslayer Optimization of Energy and Cost through Unified Modeling of User Behavior and Storage in Multiple Buildings”, which has been awarded last year to PEIK researchers, Dr. Simone Silvestri, CS Assistant Professor,

and Dr. Dan M. Ionel, ECE Professor, L. Stanley Pigman Chair in Power and PEIK Director, as PI and co-PI, respectively, has been recently expanded with a Research Experiences for Undergraduates (REU) supplement. This will allow UK undergraduate and University Scholars Program students in CS, Jackson Codispoti, and in EE, Rosemary Alden, to be actively engaged, later this summer and throughout the next academic year, in research alongside PhD students and their faculty advisors.

This NSF project studies newly proposed transformative concepts of “human-in-the-loop”, social-behavioral models, machine learning, and large-scale modeling of buildings and electric power distribution systems, leading to the development of highly efficient and reliable smart homes and grids. The research is expected to also strengthen PEIK’s partnership with regional utilities, the Electric Power Research Institute (EPRI), and National Labs.

PEIK and LG&E and KU Expand Research Collaboration on Renewable Energy and the Smart Grid



PEIK and LG&E and KU have recently expanded their collaboration program with a sponsored research project to include, alongside the integration of large solar PV power plants in the generation and transmission system, new topics of electric power distribution and smart grid technologies. Mr. Aron Patrick, Manager of Technology Research and Analytics for LG&E and KU, serves as the industrial project lead, and Dr. Dan M. Ionel, ECE Professor, L. Stanley Pigman Chair in Power, and PEIK Director, is the project PI at University of Kentucky.

Over the last year, the PEIK and LG&E and KU researchers successfully analyzed the impact of large PV penetration on the companies' generation portfolio. Using historical solar irradiance profiles from multiple sites distributed across the state of Kentucky, the study was able to estimate the maximum amount of intermittent renewable energy sources the service area can sustain without the need for significant upgrades to the existing infrastructure. This work can be adopted for vast utility applications including specifications for new generation units, utility-scale energy storage capacity requirements, and necessary transmission line upgrades for increased solar PV penetration.

LGE&E and KU and PEIK also collaborate on teaching with lectures and demonstrations by utility experts for the multidisciplinary core required class for the Power and Energy certificate at University of Kentucky, EGR 240 "Global Energy Issues", and contributions to the advanced engineering classes on special topics of electric power engineering. The two organizations also work together on professional and STEM outreach in support of the regional community.

Materials Engineering Professor and PEIK Faculty, Dr. Yang-Tse Cheng, Initiated New Projects with General Motors and Pacific Industrial Development Corporation

Materials Engineering and PEIK Faculty Dr. Yang-Tse Cheng and graduate students, are continuing research on lithium and sodium batteries for electric vehicle and power grid applications with funding from the US Department of Energy, US Department of Agriculture, Sandia National Labs, General Motors R&D Center, Ford Motors Company, and Mercedes-Benz. In 2020, a new research project was initiated with GM on developing a dry deposition method of making thick electrodes for high energy batteries. A new project was also initiated with Pacific Industrial Development Corporation on developing multi-functional battery separators. The goals of these two projects are to develop higher energy, higher power, safer, and more durable batteries for electric vehicle applications. Prof. Cheng's group is funded with more than \$1M federal and industrial sources for the next few years.

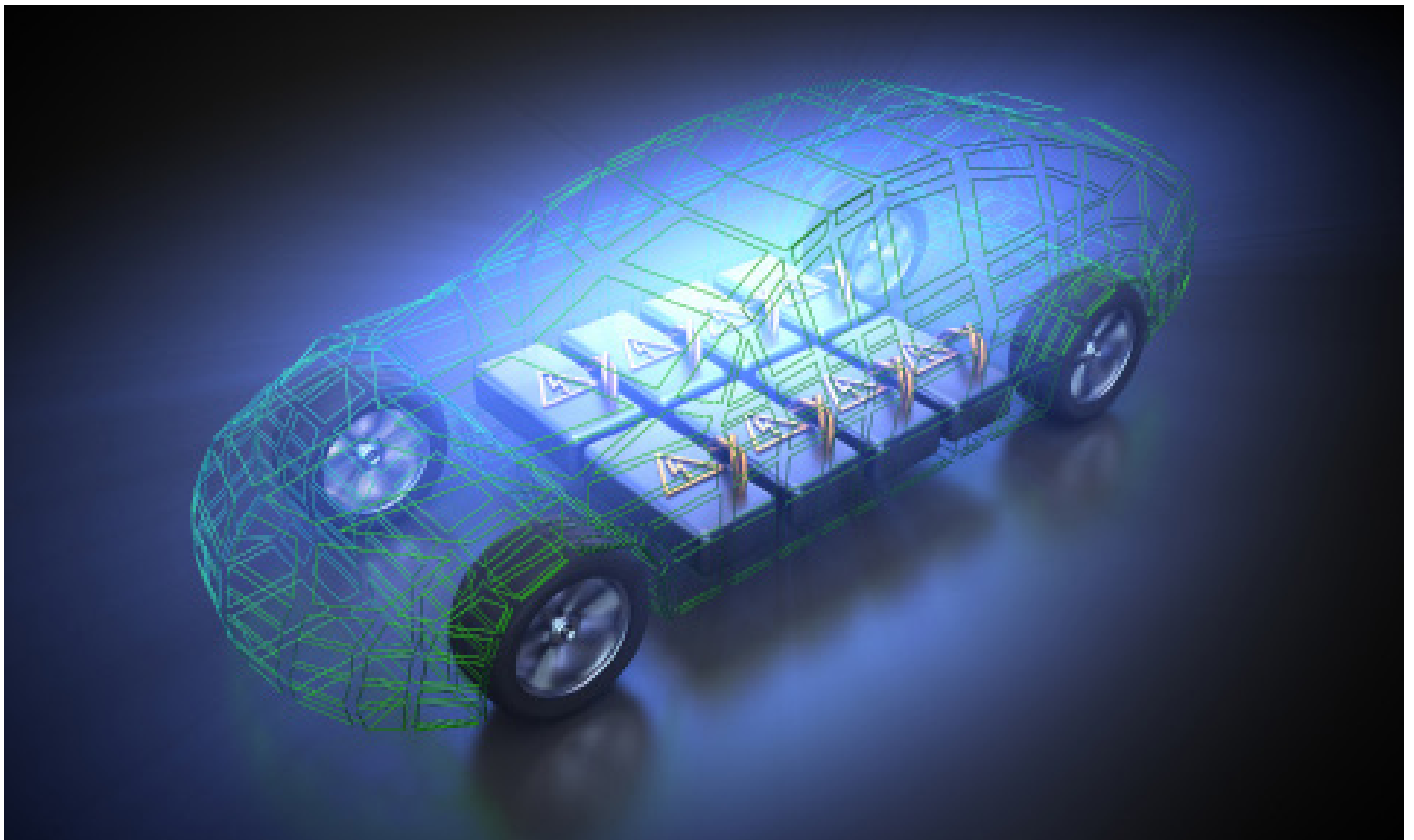

Electrical Engineering and PEIK Faculty, Dr. JiangBiao He, Received Grant from U.S. DOE APRA-E

Electrical Engineering and PEIK Faculty Dr. JiangBiao He, has been awarded a grant from the U.S. Department of Energy (DOE) Advanced Research Projects Agency–Energy (ARPA-E). In collaboration with the partner organization Marquette University, this project seeks to develop a compact, lightweight, efficient, resilient, and ultra-fast resonant direct current (DC) circuit breaker.

DC systems have many benefits over traditional AC systems such as lower cost, higher efficiency, and higher power capacity. Despite these advantages, DC based systems have lacked market adoption. A significant barrier to market adoption is the lack of adequate breakers for DC fault protection. The proposed solution combines the advantages of a vacuum interrupter (high efficiency) with a wide bandgap based resonant current source (fast response time and zero current switching of vacuum interrupter) and novel actuator topology (high force and fast response time) to produce a DC breaker that has a 4X faster response time, a 1.3X increase in power density, and a 1.3X increase of lifetime compared to current DC breakers. The proposed solution represents a transformational state of the art DC breaker that is scalable across voltage and current in MVDC applications.

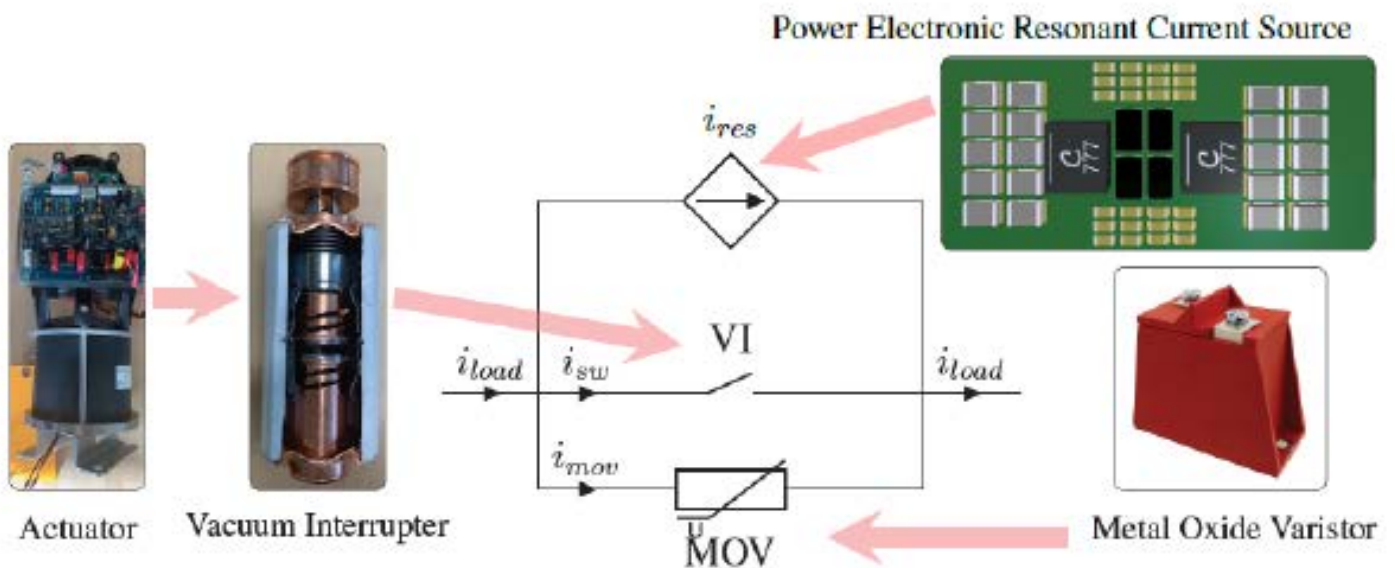

PEIK Researchers Participated in Online IEEE ICRERA 2020 Conference and Present on Progress with NSF, NASA, and Power Utility Sponsored Research

SPARK and PEIK researchers from University of Kentucky attended the 9th edition of the International Conference on Renewable Energy Research and Applications, ICRERA. The event was originally planned for Glasgow, Scotland, United Kingdom and, due to pandemic conditions, was held online on September 27-30, 2020. The ICRERA conferences typically attract large world-wide attendance with hundreds of participants. The program included many parallel sessions on specialized topics.

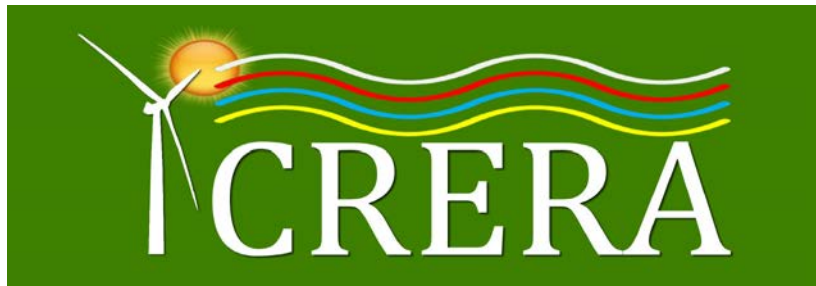

From UK, USP and PhD students Rosemary E. Alden, Donovan Lewis, and Evan S. Jones, authored and presented papers on timely topics of artificial intelligence applied to smart buildings and energy usage, electrification of transportation with a feasibility study for large cranes, and energy profiles for high efficiency buildings and solar PV distributed generators. The three research projects covered by the papers were sponsored by NSF, NASA, and Tennessee Valley Authority (TVA), respectively. Paper co-authors from UK included PhD candidates Huangjie Gong and Damien Lawhorn, and faculty: Dr. Don Colliver, F-ASHRAE, BAE Professor, Director of KIAC, and Dr. Dan M. Ionel, FIEEE, ECE Professor and L. Stanley Pigman Chair in Power, Director of SPARK and PEIK. Authors' versions of the manuscripts are available on the [SPARK Lab website](#).

SPARK and PEIK Researchers Report on DOE and NASA Sponsored Projects at the IEEE ITEC 2020 Conference



SPARK and PEIK researchers attended last week the IEEE ITEC 2020 Conference, which was held online, and reported on progress and achievements on two projects sponsored by DOE and NASA, respectively. Huangjie Gong and Damien Lawhorn, ECE PhD candidates, presented their papers: "Optimization of Aggregated EV

Power in Residential Communities with Smart Homes" and "A Network Graph Technique for the Design of Electric Aircraft Power Systems", which are co-authored by their PhD advisor, Dr. Dan M. Ionel, ECE Professor and L. Stanley Pigman Chair in Power, SPARK and PEIK Director. Authors' versions of the manuscripts are available on the [SPARK Lab website](#).

SPARK Lab Expanded Research on Electric Machines and Drives with QM Power Company

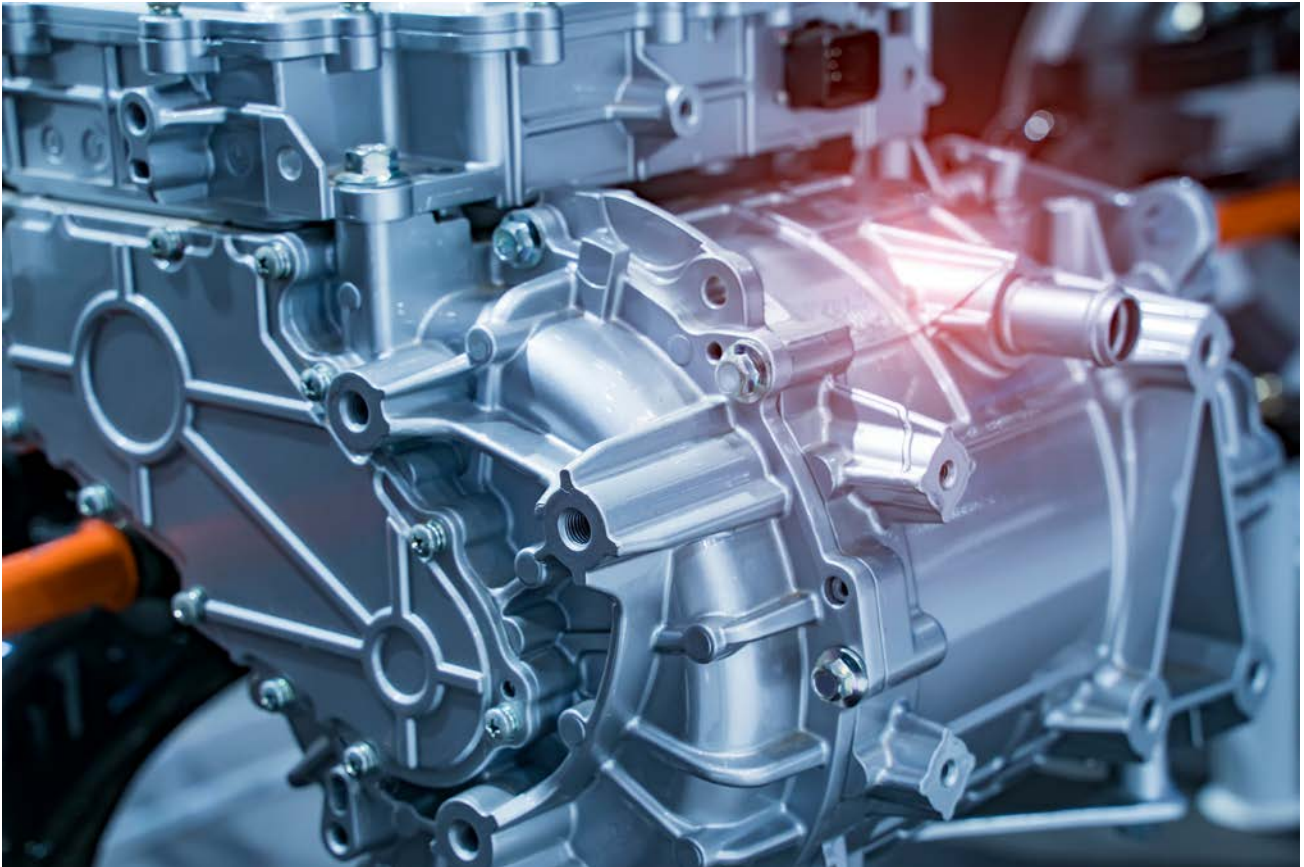

The SPARK Laboratory, which is affiliated with the Power and Energy Institute of Kentucky (PEIK) and operates within the Electrical and Computer Engineering (ECE) Department at the University of Kentucky (UK) College of Engineering, has recently expanded its collaboration with QM Power, Inc through the award of a multi-year directly sponsored project. QM Power, a start-up company based in Kansas City, MO, had its initial research and development supported, among others, by the Department of Energy (DOE), NASA, and the Office of Naval Research (ONR), and more recently successfully raised substantial private investment capital. SPARK and QM Power already collaborate on a DOE sponsored project for the future generation of machines and drives for electric vehicles.

Dr. Dan M. Ionel, ECE Professor and L. Stanley Pigman Chair in Power, Director of the SPARK Lab and of the PEIK Institute, will serve at UK as the principal investigator (PI) for the project leading a team of researchers. At QM Power, Mr. Joe Flynn, principal inventor and CTO, and Dr. Hari Harikumar, CEO, will serve as the technical and business project leads, respectively. The new project will analyze and optimize some of QM Power's innovative and patented technologies and designs by employing the SPARK Group premier expertise in electric machines and drives, low frequency electromagnetics, and applied evolutionary computational intelligence

IEEE Power and Energy Society 2020 General Meeting - SPARK and PEIK Student Presentations and Best Poster Award



SPARK and PEIK researchers participated in the largest annual conference of the IEEE Power and Energy Society. The event, which typically gathers approximately 3,000 participants and was originally scheduled for Montreal, Canada, was held online due to the pandemic conditions.

UK students presented on research sponsored by large utilities and by the National Science Foundation (NSF), respectively:

- Akeyo, O.M., Patrick, A., and Ionel, D.M., “Study of Large Solar PV Penetration on a Proposed Generation and Transmission Benchmark System”
- Gong, H., Jones, S.E., and Ionel, D.M., “An Aggregated and Equivalent Home Model for Power System Studies with Examples of Building Insulation and HVAC Control Improvements”
- Alden, R., Ababei, C., and Ionel, D.M., “Tradeoffs in Forecasting of Residential Electric Loads with Data from Smart Meters and Intelligent Circuit Breakers”.

All presentations were very well received. Rosemary Alden’s work was awarded the First Prize in the Undergraduate Student Poster Contest. Rosemary, who is a University Scholar Program student is integrating her BS and PhD studies at UK, and her research in the next academic year will be supported by an NSF REU supplement.

The image accompanying this article was taken at UK E-Day in February, prior to the implementation of social distancing guidelines. From left to right, students: Evan S. Jones, Damien L. Lawhorn, Rosemary E. Alden, Akeyo M. Oluwaseun M, and Huangjie Gong, all advised by Dan M. Ionel, Ph.D, IEEE Fellow, ECE Professor and L. Stanley Pigman Chair in Power, SPARK and PEIK Director.



PEIK Online Seminar on Energy Storage Systems Presented by Schneider Electric's Keith Waters



On May 28, 2020, Keith Waters, Industry Standards Manager at Schneider Electric presented on the topic of performance standards of Energy Storage Systems (ESS) used to supply secure power to larger systems. The seminar focused on the NFPA 70[®] (National Electric Code) Articles 705 (Interconnected Electric Power Production); 706 (Energy Storage Systems); and 710 (Stand Alone Systems). Also included was a brief overview of the current state of NEC[®] adoption. The seminar concluded with a brief discussion of other standards that will impact ESS codes/standards' future.

Rodger Reiswig of Johnson Controls Delivered a PEIK Online Seminar on Power Over Ethernet

On June 25, 2020 Rodger Reiswig, Fellow and Vice President of Industry Relations for Johnson Controls presented on the topics of power over ethernet and related impacts on industry codes and standards. The seminar also covered the convergence of these topics with the life safety industry, systems integration, and user interaction and specifically how regulations and procedures must adapt to allow technological developments. The presentation concluded with a future outlook on how the internet of things is expected to impact the life safety industry.



Schneider Electric's Remi Bolduc Delivered a PEIK Online Seminar on Harmonics Mitigation

On April 20, 2020, Remi Bolduc, Competency Centre Manager at Schneider Electric, presented on topics of high frequency components of voltage and current low voltage distribution networks. The seminar reviewed the nature of harmonics, how they are generated, and how to quantify them. Other subjects included the main harmonic standard in North America (IEEE 519-2014), directly relevant utilities grid code requirements, and available harmonic mitigation solutions. The presentation was concluded with a discussion on active harmonic filtering followed by a Q&A session.

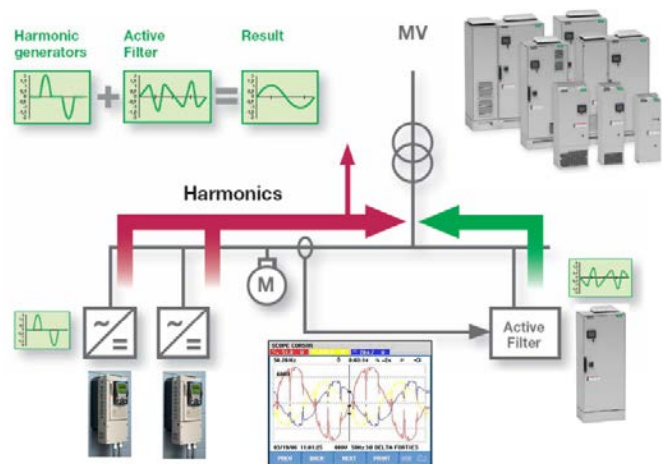

Akeyo Oluwaseun of Sargent & Lundy and Recent UK PhD and PEIK Graduate Delivered an IEEE Online Seminar on the Integration of Large PV Power Plants and Batteries



On December 17, 2020, Dr. Akeyo Oluwaseun, Senior Engineer at Sargent & Lundy, a global leading power and energy consulting firm headquartered in Chicago, IL, presented in a seminar organized by the IEEE Louisville Section. The talk was substantially based on two IEEE published papers on the topics, which were mentioned in a PEIK news earlier this month. Author's manuscript versions of the papers are available from the SPARK Lab website at UK.

At Sargent & Lundy, Dr. Akeyo focuses on engineering modeling and simulation of electric power plants and high voltage transmission systems. He recently received the PhD in Electrical Engineering from the University of Kentucky (UK) and the PEIK graduate certificate. Dr. Akeyo's doctoral research in the SPARK Lab at UK contributed to projects sponsored by Department of Energy (DOE) and in close collaboration with large utilities, especially Louisville Gas and Electric and Kentucky Utilities (LG&E and KU).

PEIK and ECE Students Established a New IEEE PES and IAS Joint Chapter at UK



A new IEEE Student Branch Chapter of the Power and Energy Society (PES) and of the Industry Application Society (IAS) has been recently established at UK following a formal process initiated last fall by a group of enthusiastic undergraduate and graduate ECE and PEIK students. The chapter was approved by the IEEE international organization in late December and started its activities at UK in the current spring semester.

The newly elected executive committee members of the student chapter, who were photographed after the 2020 E-Day at UK, are: Evan S. Jones, Damien Lawhorn, Rosemary Alden, Oluwaseun Akeyo and Huangjie Gong (left to right). Dr. Dan M. Ionel, IEEE Fellow, ECE Professor and L. Stanley Pigman Chair in Power, SPARK and PEIK Director, serves as the faculty advisor. Together with other members of the chapter, the students directly supported the stands and demonstrations of PEIK and LG&E-KU, which attracted record attendance. In addition to active participation in outreach initiatives, the students also plan other events for professional development and networking with the wider engineering community. (Photo taken prior to the pandemic.)

The Institute of Electrical and Electronic Engineers (IEEE) is the world's largest association of technical professionals with more than 400,000 members worldwide. At UK, the new PES and IAS Chapter further develops the tradition of the IEEE Student Branch that has been very active and successful for many years and reflects the growing number of students and the strong interest in electric power engineering.

PEIK and LG&E-KU Expanded Displays and New Demonstrations at UK's E-Day 2020



On Saturday February 22nd, PEIK's and LG&E-KU's joint exhibit stands at the Engineering Day, E-Day, which were organized in the atrium of the RGAN Hall, attracted a record number of visitors. Altogether, this annual edition of the UK College of Engineering event had approximately 3,000 attendees. (Photo taken prior to the pandemic.)

New this year, were the PEIK and LG&E-KU collaboration with undergraduate and graduate student members of the IEEE Power and Energy Society (PES) and Industry Applications Society (IAS) joint chapter newly established at UK, and an electric city model built by the students. Faculty and students also demonstrated older displays, which were back by popular demand, including the full-size electric bike with flashing lights and computer tablet interface, the "world's largest wind turbine" – an enlarged and modified Lego replica of Vestas V-164, a levitating and wireless supplied electric bulb, a Faraday flashlight, and a video with aerial views of real-life utility-size power systems and renewable energy installations, including Kentucky's largest electric battery and solar PV LG&E-KU power plant.

Kentucky Industrial Assessment Center



Kentucky Industrial Assessment Center, KIAC, Made Progress with Industrial Assessments and Projects

The Kentucky Industrial Assessment Center, KIAC, which is affiliated with PEIK, sends teams of faculty members and engineering students to conduct manufacturing plant energy assessments and make recommendations for potential savings opportunities. Through Department of Energy funding, the energy assessments are conducted entirely free of charge. KIAC has saved more than 95 businesses almost \$20 million, while providing significant reductions in energy use and contributing to environmental improvements and conservation. KIAC received the “National IAC of the Year” award in 2016. Dr. Don Colliver, Professor in the UK Department of Biosystems and Agricultural Engineering, serves as KIAC Director and Mr. Jason Souders is the Program Coordinator for both PEIK and KIAC.

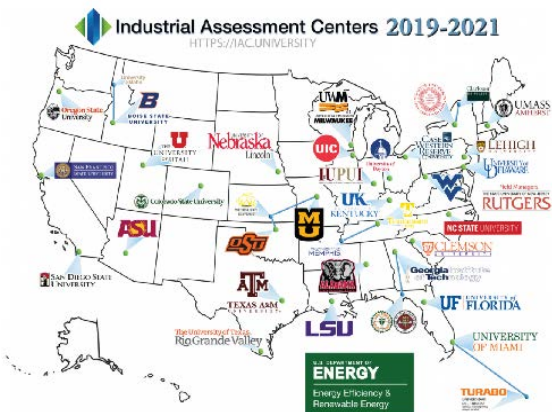

KIAC made progress with assessments in 2020. Due to pandemic conditions, site visits were very restricted, but the team was able to conduct five assessments in 2020. The team made recommendations that could save almost 1.5 million dollars if implemented. The Energy Assessments course had 12 students. (In the photo, Dr. Don Colliver (left) and Jason Souders with the PEIK and KIAC expo display at the last Kentucky Governor’s Conference on Energy and the Environment held in person in 2019, prior to the pandemic.)



Power and Energy
Institute of Kentucky

University of Kentucky
College of Engineering
453 F. Paul Anderson Tower
Lexington KY 40506



www.engr.edu/power



www.linkedin.com/company/power-and-energy-institute-of-kentucky



twitter.com/PEIKUK

